

1

2

3

4

Notes: (Unless Otherwise Specified)

- 1. Waterproof Rate: IP68.
- 2. RoHS Compliant.

REV	ECN#	DESCRIPTION OF REVISION	DRAW BY DATE	CHECK BY DATE	APPROVE BY DATE
01			Hank 06/22/17	Lucas 06/22/17	Ray 06/22/17

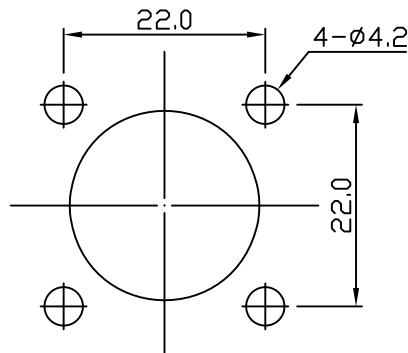
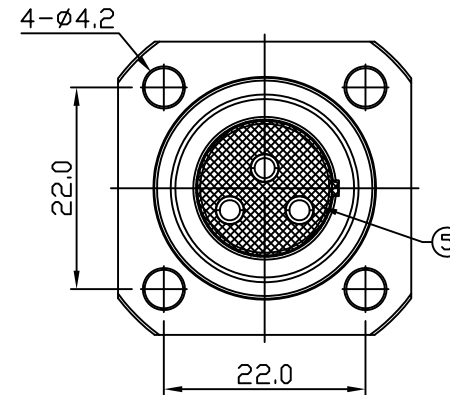
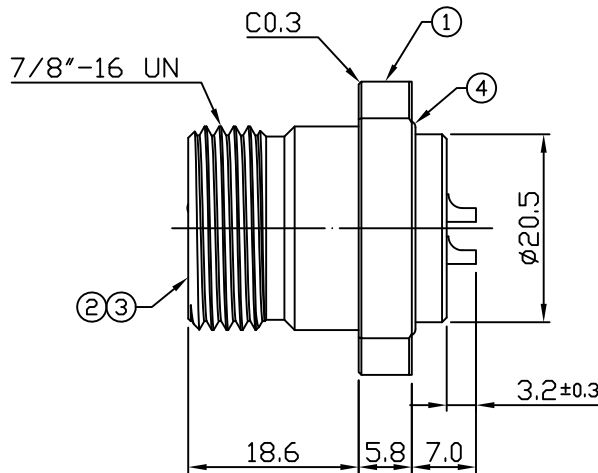
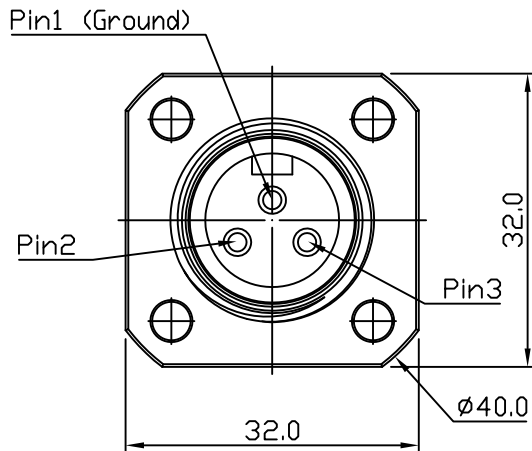

Recommend Panel Cut-Out



5	Glue	Epoxy Color: Black	
4	O-Ring	Silicone Color: Red	1
3	Contacts	Copper Alloy Finish: Au Plated	3
2	Housing	PVC Color: Black	1
1	Metal Body	Copper Alloy Finish: Ni Plated	1
Item	Part Name	Material / Finish	Q'ty

GT Contact CO.,LTD

NOTICE OF PROPRIETARY PROPERTY:
THE INFORMATION CONTAINED HEREIN IS THE PROPRIETARY PROPERTY OF GT Contact CO.,LTD THE POSSESSOR AGREES TO THE FOLLOWING:
 (1) TO MAINTAIN THIS DOCUMENT IN CONFIDENCE
 (2) NOT TO REPRODUCE OR COPY IT
 (3) NOT TO REVEAL OR PUBLISH IT IN WHOLE OR PART
 (4) ALL RIGHTS RESERVED

TITLE						DRAWING NUMBER			REV.	
Mini 13A 3P Panel Front mount Square flange Male Solder						GT272218-04030			01	
	B	1:1	Hank 06/22/17	Lucas 06/22/17	Ray 06/22/17	X.X ± 0.5 X.XX ± 0.2	X.XXX ± 0.05 ANGLES ± 1°	mm	1/1	
THIRD ANGLE PROJECTION	SIZE	SCALE	DRAW / DATE	CHECK / DATE	APPROVE / DATE	TOLERANCES		UNIT	SHEET	

1

2

3

4