

4

3

2

1

Notes: (Unless Otherwise Specified)

1. Ingress Protection Rating: IP67
2. RoHS Compliance.
3. Cable: UL2464 24AWG, Black

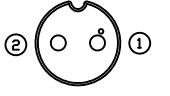
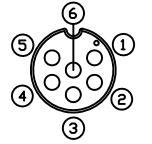
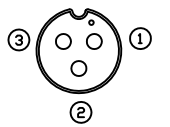
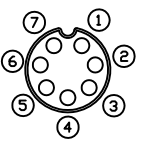
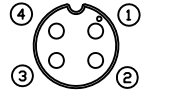
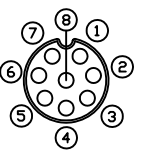
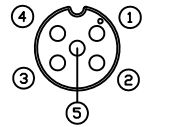
Item	P/N	Pin Assignment	Item	P/N	Pin Assignment
1	GT152225-02021-XX		5	GT152225-02061-XX	
2	GT152225-02031-XX		6	GT152225-02071-XX	
3	GT152225-02041-XX		7	GT152225-02081-XX	
4	GT152225-02051-XX				

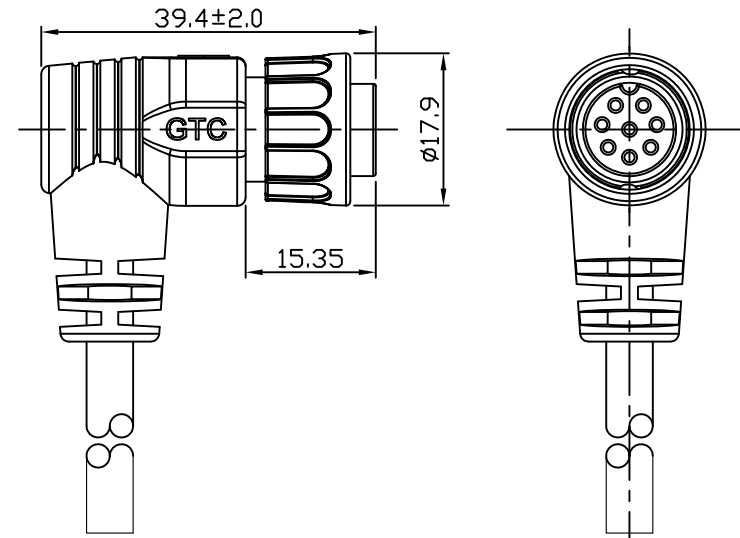

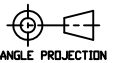
METRIC		GT Contact CO.,LTD	
DRAFTER	DATE	NOTICE OF PROPRIETARY PROPERTY: THE INFORMATION CONTAINED HEREIN IS THE PROPRIETARY PROPERTY OF GT Contact CO.,LTD THE POSSESSOR AGREES TO THE FOLLOWING: (a) TO MAINTAIN THIS DOCUMENT IN CONFIDENCE (b) NOT TO REPRODUCE OR COPY IT (c) NOT TO REVEAL OR PUBLISH IT IN WHOLE OR PART (d) ALL RIGHTS RESERVED	
DESIGNER	DATE		
DIMENSIONS ARE IN MILLIMETER TOLERANCES X.X ±0.5 X.XX ±0.20 X.XXX ±0.05 ANGLES ±0.5° DO NOT SCALE DRAWINGS		TITLE C2 5A 2-8P Cable end 90 Female Lock with UL2464 cable	
 THIRD ANGLE PROJECTION		DRAWING NUMBER GT152225-02XX1-XX	REV. 01
SIZE B		SCALE N/A	SHT 1 OF 1

4

3

2

D

D

C

C

B

B

A

A