

Notes: (Unless Otherwise Specified)

1. Waterproof Rate: IP67.
2. Recommend Panel Thickness: 0.8 to 4.0 mm.
3. Recommend Torque: 9.0~10.0 Kgf-cm.
4. Mating Cap P/N: GT1C5221X2.
5. RoHS Compliant.

REV	ECN#	DESCRIPTION OF REVISION	DRAW BY DATE	CHECK BY DATE	APPROVE BY DATE
A0	ECN-151016		Lucas 05/24/16	Lucas 05/24/16	Ray 05/24/16

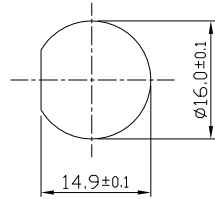

Recommend
Panel Cut-Out

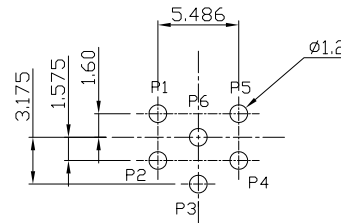
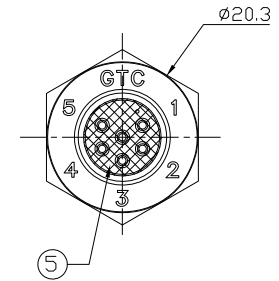
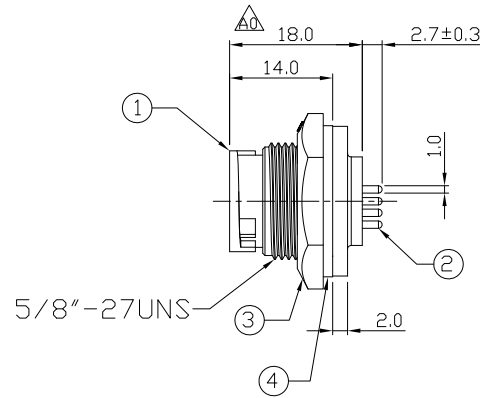
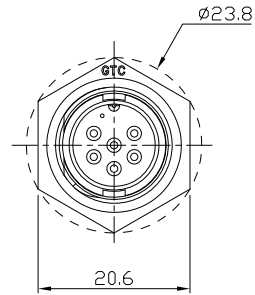

Recommend PCB Layout
Scale 2:1

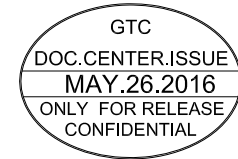

5	Glue	Epoxy Color: Black	
4	Gasket	Silicone Color: Black	1
3	Hex Nut	Thermoplastic Color: Black	1
2	Contacts	Copper Alloy Finish: Au Plated	6
1	Housing	Thermoplastic Color: Black	1
Item	Part Name	Material / Finish	Q'ty

TITLE						DRAWING NUMBER			REV.
C2 5A 6P Panel Male Dip Lock						GT152210-12060			A0
THIRD ANGLE PROJECTION	SIZE	SCALE	DRAW / DATE	CHECK / DATE	APPROVE / DATE	TOLERANCES	UNIT	SHEET	
	B	1:1	Karen 04/15/09	Robbie 04/15/09	Robbie 04/15/09	X.X ± 0.5 X.XX ± 0.2	mm	1/1	
						X.XXX ± 0.05 ANGLES ± 1°			

GT Contact CO.,LTD

NOTICE OF PROPRIETARY PROPERTY:
THE INFORMATION CONTAINED HEREIN IS THE PROPRIETARY PROPERTY OF GT Contact CO.,LTD THE POSSESSOR AGREES TO THE FOLLOWING:
(i) TO MAINTAIN THIS DOCUMENT IN CONFIDENCE
(ii) NOT TO REPRODUCE OR COPY IT
(iii) NOT TO REVEAL OR PUBLISH IT IN WHOLE OR PART
(iv) ALL RIGHTS RESERVED