

Notes: (Unless Otherwise Specified)

1. Waterproof Rate: IP67.
2. Recommend Panel Thickness: 0.8 to 5.0 mm.
3. Recommend Torque: 6~7 Kgf-cm.
4. Mating Cap P/N: GT1C5121X2.
5. RoHS Compliant.

REV	ECN#	DESCRIPTION OF REVISION	DRAW BY DATE	CHECK BY DATE	APPROVE BY DATE
A0	ECN-130308	Mass Production	Lucas 03/13/13	Ray 03/13/13	Ray 03/13/13

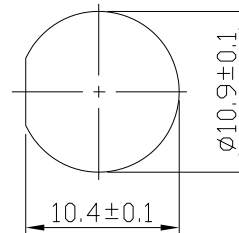
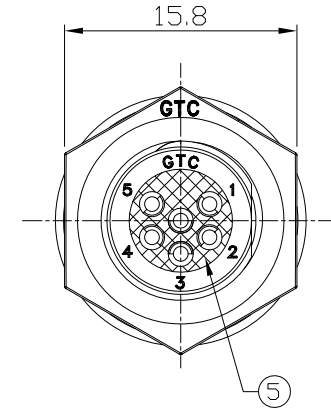
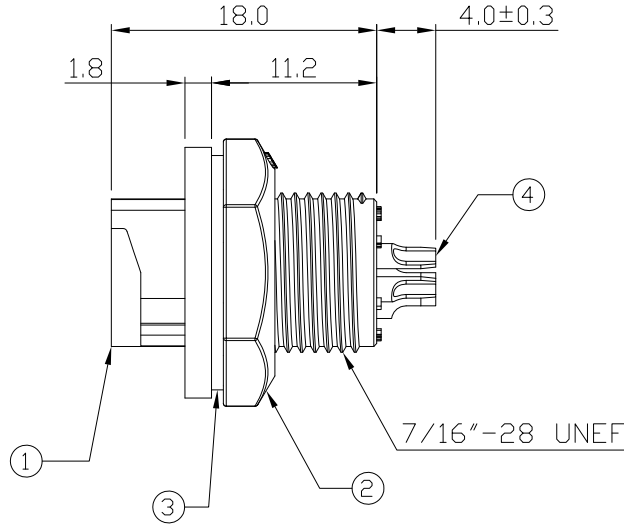
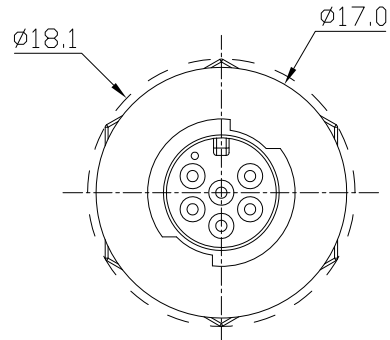

Recommended  
Panel Cut-Out

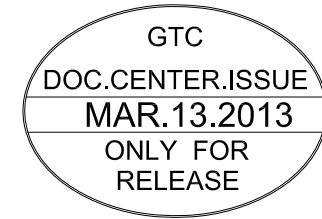

Item	Part Name	Material / Finish	Q'ty
5	Glue	Epoxy Color: Black	
4	Contacts	Copper Alloy Finish: Au Plated	6
3	Gasket	Silicone Color: Black	1
2	Hex Nut	Thermoplastic Color: Black	1
1	Housing	Thermoplastic Color: Black	1

TITLE						DRAWING NUMBER			REV.
C1 2A 6P Panel Rear Mount Male Solder Lock						GT151211-01060			A0
THIRD ANGLE PROJECTION	SIZE	SCALE	DRAW / DATE	CHECK / DATE	APPROVE / DATE	TOLERANCES	UNIT	SHEET	
	B	1:1	Lucas 08/16/12	Lucas 08/16/12	Ray 08/16/12	X.X ± 0.5 X.XX ± 0.2	mm	1/1	
						X.XXX ± 0.05 ANGLES ± 1°			

GT Contact CO.,LTD

NOTICE OF PROPRIETARY PROPERTY:  
THE INFORMATION CONTAINED HEREIN IS THE PROPRIETARY PROPERTY OF GT CONTACT CO.,LTD THE POSSESSOR AGREES TO THE FOLLOWING:  
(i) TO MAINTAIN THIS DOCUMENT IN CONFIDENCE  
(ii) NOT TO REPRODUCE OR COPY IT  
(iii) NOT TO REVEAL OR PUBLISH IT IN WHOLE OR PART  
(iv) ALL RIGHTS RESERVED