

Notes: (Unless Otherwise Specified)

1. Waterproof Rate: IP67.
2. Recommend Panel Thickness: 0.8 To 2.0 mm.
3. Recommend Torque: 5~6 Kgf-cm.
4. Durability: 100 Cycles Min.
5. DWV: 900 Vrms.
6. Rated Voltage: 60V AC/DC.
7. Insulation Resistance: 100 MΩ Min.
8. RoHS Compliant.

REV	ECN#	DESCRIPTION OF REVISION	DRAW BY DATE	CHECK BY DATE	APPROVE BY DATE
01			Lucas 02/18/19	Lucas 02/18/19	Ray 02/18/19

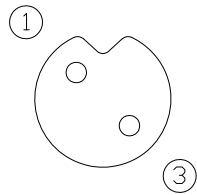

Front View  
Pin Assignment

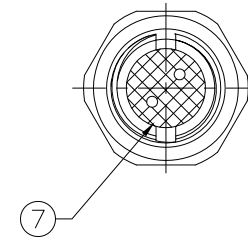
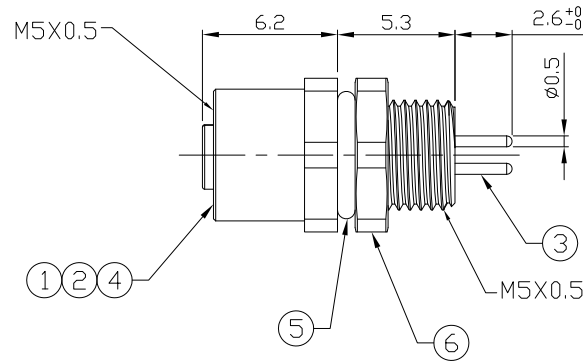
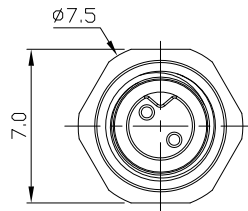

7	Glue	Epoxy Color: Black	
6	Hex Nut	Copper Alloy Finish: Ni Plated	1
5	O-Ring	NBR Color: Black	1
4	O-Ring	NBR Color: Red	1
3	Contacts	Copper Alloy Finish: Au Plated	2
2	Housing	Thermoplastic Color: Black	1
1	Metal Body	Copper Alloy Finish: Ni Plated	1
Item	Part Name	Material / Finish	Q'ty

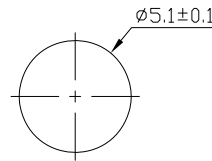

Recommend  
Panel Cut-Out

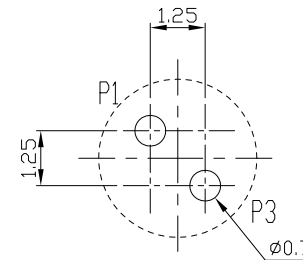

Recommend PCB Layout Component Side

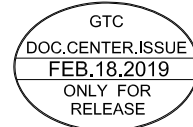

GT Contact CO.,LTD

NOTICE OF PROPRIETARY PROPERTY:

THE INFORMATION CONTAINED HEREIN IS THE PROPRIETARY PROPERTY OF GT Contact CO.,LTD THE POSSESSOR AGREES TO THE FOLLOWING:  
 (a) TO MAINTAIN THIS DOCUMENT IN CONFIDENCE  
 (b) NOT TO REPRODUCE OR COPY IT  
 (c) NOT TO REVEAL OR PUBLISH IT IN WHOLE OR PART  
 (d) ALL RIGHTS RESERVED

TITLE						DRAWING NUMBER			REV.	
M5 1A 2P Panel Rear Mount Female Dip						GT231103-15020			01	
	B	2:1	Lucas 02/18/19	Lucas 02/18/19	Ray 02/18/19	X.X X.XX	± 0.5 ± 0.2	ANGLES ± 1°	mm	1/1
THIRD ANGLE PROJECTION	SIZE	SCALE	DRAW / DATE	CHECK / DATE	APPROVE / DATE	TOLERANCES		UNIT	SHEET	