

Notes: (Unless Otherwise Specified)

1. Waterproof Rate: IP67.
2. Recommend Panel Thickness: 0.8 to 3.5 mm.
3. Recommend Torque: 9~10 Kgf-cm.
4. Mating Cap P/N: GT1C5221X2.
5. RoHS Compliant.

REV	ECN#	DESCRIPTION OF REVISION	DRAW BY DATE	CHECK BY DATE	APPROVE BY DATE
A0	ECN-141007	Mass Production	Joyce 10/17/14	Lucas 10/17/14	Ray 10/17/14

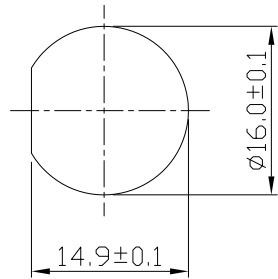

Recommend Panel Cut-Out

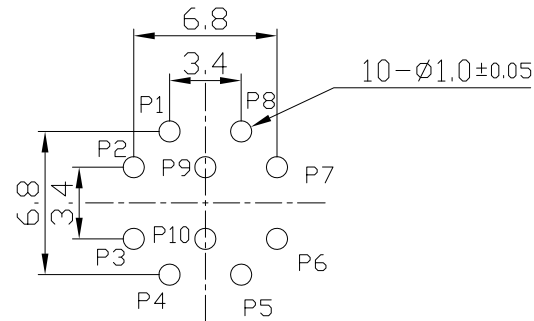
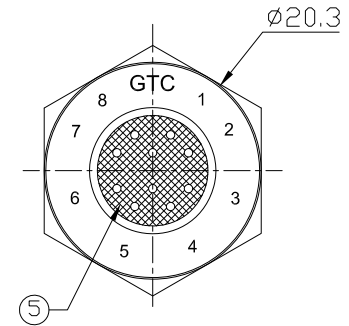
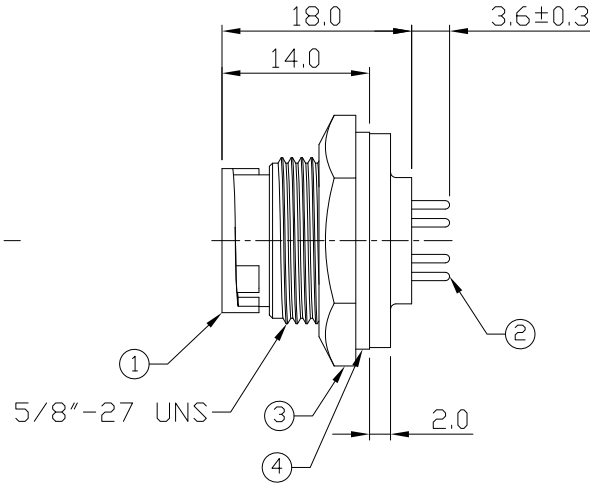
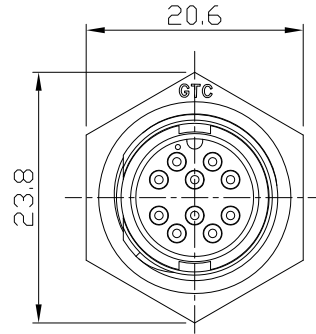

Recommend PCB Layout
Scale 2:1

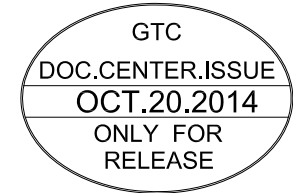

Item	Part Name	Material / Finish	Qty
5	Glue	Epoxy Color: Black	
4	Gasket	Silicone Color: Black	1
3	Hex Nut	Thermoplastic Color: Black	1
2	Contacts	Copper Alloy Finish: Au Plated	10
1	Housing	Thermoplastic Color: Black	1

TITLE						DRAWING NUMBER			REV.
C2 2A 10P Panel Male Dip Lock						GT152210-11100			A0
THIRD ANGLE PROJECTION	SIZE	SCALE	DRAW / DATE	CHECK / DATE	APPROVE / DATE	TOLERANCES	UNIT	SHEET	
	B	N/A	Lucas 03/23/10	Ray 03/23/10	Ray 03/23/10	X.X ± 0.5 X.XX ± 0.2	mm	1/1	
						X.XXX ± 0.05 ANGLES ± 1°			

GT Contact CO.,LTD

NOTICE OF PROPRIETARY PROPERTY:
THE INFORMATION CONTAINED HEREIN IS THE PROPRIETARY PROPERTY OF GT CONTACT CO.,LTD THE POSSESSOR AGREES TO THE FOLLOWING:
(i) TO MAINTAIN THIS DOCUMENT IN CONFIDENCE
(ii) NOT TO REPRODUCE OR COPY IT
(iii) NOT TO REVEAL OR PUBLISH IT IN WHOLE OR PART
(iv) ALL RIGHTS RESERVED