

1

2

3

4

Notes: (Unless Otherwise Specified)

1. Waterproof Rate: IP67.
2. Recommend Panel Thickness: 0.8 to 3.0 mm.
3. Recommend Torque: 9~10 Kgf-cm.
4. Mating Cap P/N: GT1C1210X2.
5. RoHS Compliant.
6. Type C AB面接點需跟圖面一致.
7. UL Certification file #E364108.

REV	ECN#	DESCRIPTION OF REVISION	DRAW BY DATE	CHECK BY DATE	APPROVE BY DATE
08	ECN-201015	Copper foil wrap => metal shell cover	Lucas 10/27/20	Lucas 10/27/20	Ray 10/27/20

GTC  
DOC.CENTER.ISSUE  
OCT.29.2020  
ONLY FOR  
RELEASE

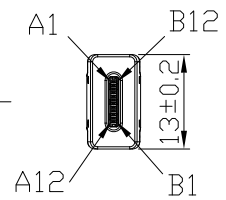
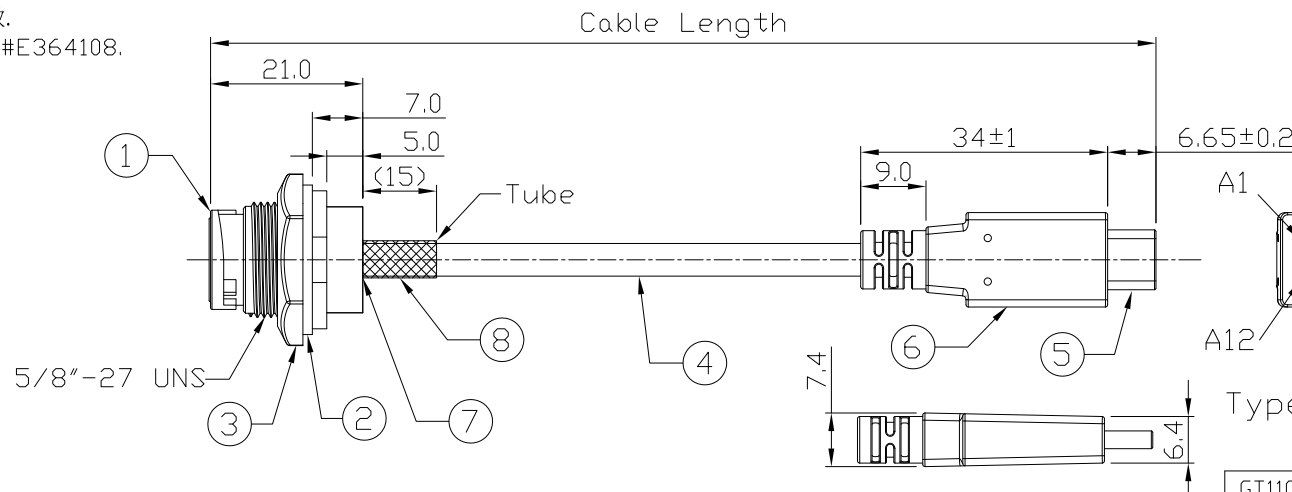
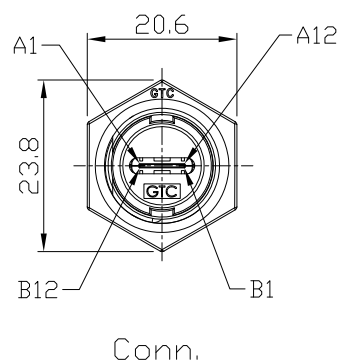

Type C Plug 08

Item	Part Name	Material / Finish	Q'ty
8	Shrink Tube	L=20mm, Heat Shrink Tube With Adhesive Lined Color: Black	1
7	Glue	Epoxy Color: Black	1
6	Over Mold	PVC Color: Black	1
5	USB Type C 3.1	Housing: Thermoplastic, Color: Black Contacts: Copper Alloy, Finish: Au Plated Shell: Stainless Steel, Finish: Au Plated	1
4	Cable	UL21572 (1P/32#+EAM)*4+(1P/32#+A)+(4C/32#)+(1C/24#)+2EAB 85% DD:4.8mm BLACK TPE JACKET.	1
3	Hex Nut	Thermoplastic Color: Black	1
2	Gasket	Silicone Color: Black	1
1	Housing	Thermoplastic Color: Black	1

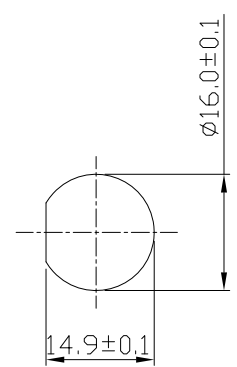

Recommend  
Panel Cut-Out

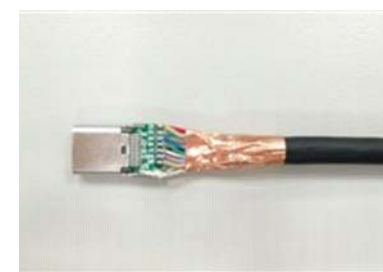

編織需跟雙面導電銅箔導通跟PCB板距離4~5mm

GT11C200-01-02	2000 mm	+100
GT11C200-01-01	1000 mm	+50
GT11C200-01-Z9	900 mm	+50
GT11C200-01-Z8	800 mm	+50
GT11C200-01-Z7	700 mm	+50
GT11C200-01-Z6	600 mm	+50
GT11C200-01-Z5	500 mm	+50
GT11C200-01-Z4	400 mm	+50
GT11C200-01-Z3	300 mm	+25
GT11C200-01-Z2	200 mm	+25
GT11C200-01-Z1	100 mm	+25
Part No.	Cable Length	Tol.

GT Contact CO.,LTD

NOTICE OF PROPRIETARY PROPERTY:  
THE INFORMATION CONTAINED HEREIN IS THE PROPRIETARY PROPERTY OF GT Contact CO.,LTD THE POSSESSOR AGREES TO THE FOLLOWING:  
(1) TO MAINTAIN THIS DOCUMENT IN CONFIDENCE  
(2) NOT TO REPRODUCE OR COPY IT  
(3) NOT TO REVEAL OR PUBLISH IT IN WHOLE OR PART  
(4) ALL RIGHTS RESERVED

TITLE						DRAWING NUMBER			REV.	
USB 3.1 Type C Plastic C2 Panel Jack Lock With Type C Plug						GT11C200-01-XX			08	
	B	1:1	Lucas 09/02/16	Ray 09/02/16	Ray 09/02/16	X.X ± 0.5 X.XX ± 0.2	X.XXX ± 0.05 ANGLES ± 1°	mm	1/3	
THIRD ANGLE PROJECTION	SIZE	SCALE	DRAW / DATE	CHECK / DATE	APPROVE / DATE	TOLERANCES		UNIT	SHEET	

1

2

3

4

1

2

3

4

REV	ECN#	DESCRIPTION OF REVISION	DRAW BY DATE	CHECK BY DATE	APPROVE BY DATE
08	ECN-201015	Copper foil wrap => metal shell cover	Lucas 10/27/20	Lucas 10/27/20	Ray 10/27/20

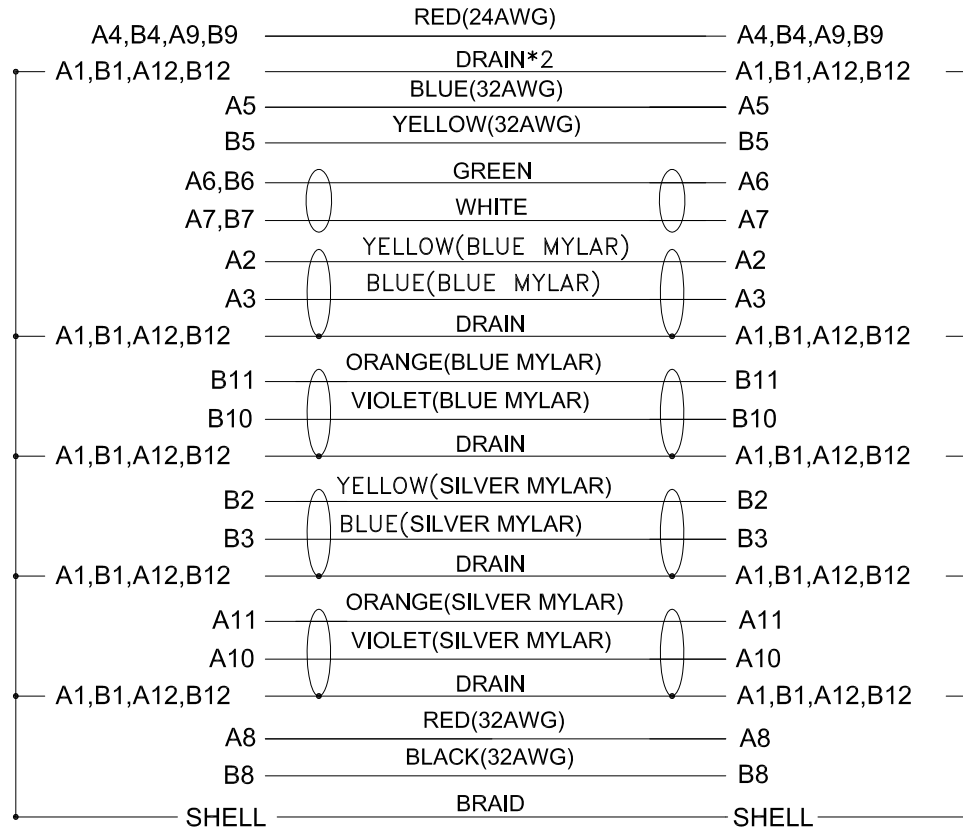

Conn.

Type C Plug

Wiring Diagram

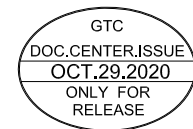

GT Contact CO.,LTD

NOTICE OF PROPRIETARY PROPERTY:

THE INFORMATION CONTAINED HEREIN IS THE PROPRIETARY PROPERTY OF GT Contact CO.,LTD THE POSSESSOR AGREES TO THE FOLLOWING:  
 (i) TO MAINTAIN THIS DOCUMENT IN CONFIDENCE  
 (ii) NOT TO REPRODUCE OR COPY IT  
 (iii) NOT TO REVEAL OR PUBLISH IT IN WHOLE OR PART  
 (iv) ALL RIGHTS RESERVED

TITLE						DRAWING NUMBER			REV.
USB 3.1 Type C Plastic C2 Panel Jack Lock With Type C Plug						GT11C200-01-XX			08
	B	1:1	Lucas 09/02/16	Ray 09/02/16	Ray 09/02/16	X.X ± 0.5 X.XX ± 0.2	X.XXX ± 0.05 ANGLES ± 1°	mm	2/3
THIRD ANGLE PROJECTION	SIZE	SCALE	DRAW / DATE	CHECK / DATE	APPROVE / DATE	TOLERANCES		UNIT	SHEET

1

2

3

4

1

2

3

4

REV	ECN#	DESCRIPTION OF REVISION	DRAW BY DATE	CHECK BY DATE	APPROVE BY DATE
08	ECN-201015	Copper foil wrap => metal shell cover	Lucas 10/27/20	Lucas 10/27/20	Ray 10/27/20

\*\*\*CONSTRUCTION:

1.CABLE:

\* UL21572(1P/32#+EAM)\*4+(1P/32#+A)+(4C/32#)+(1C/24#)+2EAB 85%  
 OD:4.8mm BLACK TPE JACKET.

\*\*\*CONNECTOR:

2.USB C/M:

\* USB TYPE C MALE SOLDER TYPE,PCB WITHOUT IC,  
 \* PINS: 30u GOLD PLATED OVER NICKEL.  
 \* INSULATOR: BLACK THEMOPLASTIC 94V-0 RATED.  
 \* SHELL: STEEL WITH GOLD PALTED.  
 \* COVER: STEEL WITH NI PALTED.  
 \* CAPACITOR.  
 \* MOLDED: BLACK PVC 45P.

3.USB C/F:

\* USB TYPE C FEMALE SOLDER TYPE,PCB WITHOUT IC,  
 \* PINS: 30u GOLD PLATED OVER NICKEL.  
 \* INSULATOR: BLACK COLOR LCP 94V-0 RATED.  
 \* SHELL: STEEL WITH GOLD FLASH.

4.TEST:

\* CT: 2 ohm IS: 5M ohm



GT Contact CO.,LTD

NOTICE OF PROPRIETARY PROPERTY:  
 THE INFORMATION CONTAINED HEREIN IS THE PROPRIETARY PROPERTY OF GT Contact CO.,LTD THE POSSESSOR AGREES TO THE FOLLOWING:  
 (i) TO MAINTAIN THIS DOCUMENT IN CONFIDENCE  
 (ii) NOT TO REPRODUCE OR COPY IT  
 (iii) NOT TO REVEAL OR PUBLISH IT IN WHOLE OR PART  
 (iv) ALL RIGHTS RESERVED

TITLE USB 3.1 Type C Plastic C2 Panel Jack Lock With Type C Plug						DRAWING NUMBER GT11C200-01-XX			REV. 08
	B	1:1	Lucas 09/02/16	Ray 09/02/16	Ray 09/02/16	X.X ± 0.5 X.XX ± 0.2	X.XXX ± 0.05 ANGLES ± 1°	mm	3/3
THIRD ANGLE PROJECTION	SIZE	SCALE	DRAW / DATE	CHECK / DATE	APPROVE / DATE	TOLERANCES		UNIT	SHEET

1

2

3

4